



DATA SHEET

Article number: 09144899

residual current circuit-breaker

DFS 6 063-4/0,03-B SK NU

AC/DC sensitive type B, with mains monitoring

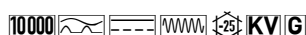

Function

Residual current circuit-breakers (RCCBs) are components for implementing protective measure "Automatic disconnection of the power supply" as per IEC 60364-4-41 or corresponding national installation regulations. Devices of the DFS 6 series are four-pole residual current circuit breakers for one- or three-phase networks. They also have large two-tier terminals for accommodating large conductor cross-sections and a practical multifunctional switching knob for easier error searches and can be easily provided with labels using free-of-charge software. Type B residual current circuit-breakers detect smooth DC residual currents and all other residual currents at frequencies up to 150,000 Hz. The operating voltage required for this is taken from the mains supply. Correct power supply is ensured when the voltage between the mains conductors is ≥ 50 V. Pulsating and AC residual currents are detected independent of the mains voltage. For residual current circuit-breakers with characteristic curve SK, the frequency response of the tripping current is designed so that residual currents with high frequencies, such as in the clock frequency range for frequency converters, as opposed to the rated frequency are detected with significantly reduced sensitivity. Undesired trips caused by leakage currents can therefore be widely avoided. However, fire protection depending on the rated residual current of the switch (0.03 A, 0.1 A or 0.3 A) is only provided for residual currents with frequencies up to 1 kHz, 300 Hz or 100 Hz, while the devices with tripping current frequency response B+ or NK offer protection over the entire tripping frequency range up to 20 kHz or 150 kHz, respectively. Thanks to the mains monitoring function, our NU RCCBs also trip in the event of input-side mains disturbances, such as a neutral conductor interruption. This reliably protects electrical equipment against overvoltage damage.

Features

High level of immunity against leakage and residual currents due to operational conditions from frequency 1 kHz and higher, AC/DC sensitive for residual currents with frequencies and mixed frequencies of 0 Hz (smooth direct current) up to 150 kHz, high availability even of voltage-independent detection of smooth DC residual current and AC residual current with frequencies not equal to 50/60 Hz thanks to full functional compatibility with mains voltages from at least 50 V AC on any two active conductors, mains-voltage-independent tripping when type A residual currents occur, compact design for all rated currents, high short-circuit resistance, double-sided two-tier terminals for large conductor cross-section and busbar, switch position indicator, viewing window for labels, multifunction switch toggle with three positions: "on", "off" and "tripped", Neutral conductor position left

Mounting

quick fastening to mounting rail, any installation position, supply preferably from above

Applications

Commercial and industrial installations with TT, TN-S and TN-C-S systems, where power electronics equipment is used without galvanic isolation from the mains, e.g. frequency converters, switching power supplies, high-frequency converters, photovoltaic installations and UPS equipment with frequency converters without transformers.

Notes

suitable for use in 50 Hz AC networks, RCCBs for other frequencies available upon request, Not designed for use in direct current networks or on the output side of controlled electrical equipment such as frequency converters.

Accessories

terminal caps KA, information stickers HAS, auxiliary switches DHi, restart locks DFS WES, software DBS

Technical Data

Series	DFS 6 B SK NU
Number of poles	4
Residual current type	B
Tripping characteristic curve	SK
Rated current (AC)	63 A
Rated residual current $I_{\Delta n}$	0.03 A
Short-time delayed	true
Selective	false

min. Operating voltage range of test circuit	250 V
max. Operating voltage range of test circuit	440 V
Minimum rated operating voltage (Type A/AC operation)	0 V AC
Minimum rated operating voltage (Type B operation)	50 V AC
Non-trip time	10 ms
Tripping frequency	0 Hz ... 150 kHz
Maximum disconnection times	1 · IΔn: ≤ 300 ms; 5 · IΔn: ≤ 40 ms
Display elements	Switch position indicator, active conductors, Network error indicator, Operating
Control elements	Switching knob, Residual current test button
Network fault detection	Phase failure, N conductor interruption, L and N conductor mix-up
Protective functions	Residual current protection
	Error voltage monitoring
Rated residual voltage	20 V
max. Switch-off time error voltage ≥ 50 V	150 ms
Non-trip time	70 ms
Trip threshold for voltage unbalance	5 % ... 10 %
Internal consumption	max. 3 W
	load circuit
Specification	load disconnect contact
min. Contact opening	4 mm
Rated voltage (AC)	230 V, 400 V
Rated current (AC)	63 A
Rated short-circuit current	10 kA
Surge current strength	3 kA
max. Total rated switching capacity	630 A
Rated insulation voltage	400 V
Rated impulse withstand voltage	4 kV
Rated frequency	50 Hz
Current heat loss per current path	3.1 W
Thermal Backup-fuse OCPD	63 A
Short-circuit backup-fuse SCPD	100 A
Back-up fuse type	gG
I ² t strength	48 kA ² s
Dynamic current strength I _p	6 kA
	Screw-type terminal top and bottom (load circuit)
Neutral conductor position	left
Protection against direct contact	DGUV V3, VDE 0660-514, finger and back-of-hand proof
Connection C1 Maximum number of conductors per terminal	2 (conductors of same type and cross-section)
Cross section solid	1-wire: 1.5 mm ² ... 50 mm ² ; 2-wire: 1.5 mm ² ... 16 mm ²
Connecting capacity flexible	1-wire: 1.5 mm ² ... 50 mm ² ; 2-wire: 1.5 mm ² ... 16 mm ²
Cross section stranded	1-wire: 1.5 mm ² ... 50 mm ² ; 2-wire: 1.5 mm ² ... 16 mm ²
Cross section AWG, solid	15 ... 1
Cross section AWG, stranded	15 ... 1
Cross section AWG, flexible	15 ... 1
Cross section AWG, flexible with ferrule	15 ... 1
Tightening torque	2.5 Nm ... 3 Nm
	General data
Operating position	optional
max. operating altitude above MSL	2000 m
mechanical endurance	min. 5000 cycles
electrical endurance	min. 2000 cycles
Surrounding atmosphere	normal environmental conditions
Storage temperature	-40 °C ... 70 °C
Ambient temperature	-25 °C ... 40 °C
Climate resistance	according to IEC 60068-2-30: humid heat / cyclic (25 °C / 55 °C; 93 % / 97 % RH)
Shock resistance	20 g / 20 ms duration
Fatigue limit	> 5 g (f ≤ 80 Hz, duration > 30 min.)
Housing type	distribution board housing
Installation type	Mounting rail (35 mm)
Housing material	thermoplastic
Protection class	IP20 (installed: IP40)
sealable	true
Width	108 mm
Height	85 mm
Depth	75 mm
Installation depth	69 mm
Module widths	6
Weight	0.59 kg

Dimensions

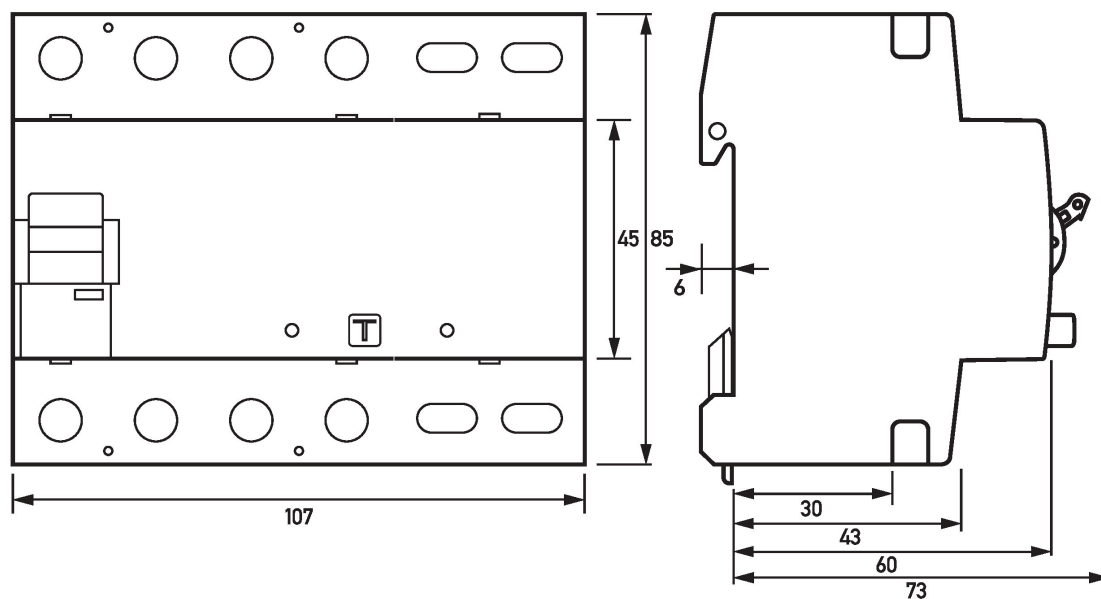

Dimensional drawing DFS 6 B SK NU, 4 pole (Group view)

Wiring example

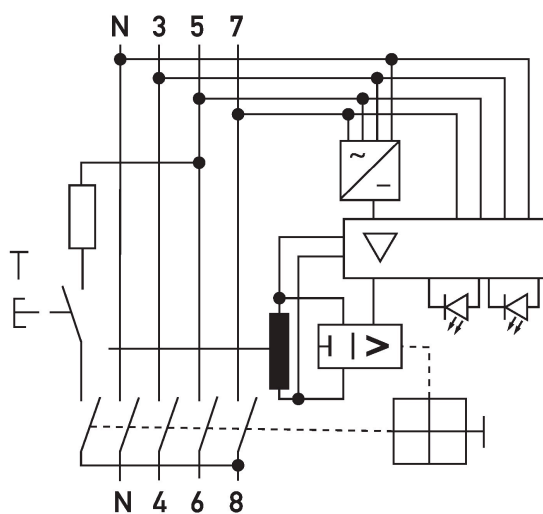

Wiring diagram DFS 6 B SK NU, 4 pole

Diagrams

